

2MP ColourHunter Fixed Turret Analog Camera

UAC-T112-AF28(40)-W



Introduction

UAC-T112-AF28(40)-W is a 2MP ColourHunter fixed turret analog camera with a high-performance 1/3-inch CMOS sensor and 3D noise reduction technology. It supports TVI/AHD/CVI/CVBS, which effectively enhances product adaptability and diversity of networking solutions. With SYV-75-3 or other coaxial cable types, the camera can achieve low-cost, long-distance, and anti-interference mega-pixel HD video transmission without time delay. The camera also supports audio input and synchronous transmission of audio and video.

Features

- 2MP high quality image
- TVI/AHD/CVI/CVBS
- Supports white light illumination, 24/7 color images
- 3D noise reduction technology delivers clean and sharp images
- Supports 180° horizontal flip, 180° vertical flip
- OSD configuration menu, easy to operate
- IP67 waterproof and dustproof design, high reliability
- OSD configuration menu in 11 languages
- Built-in microphone for high quality audio transmission via coaxial cables

Specifications

Model	UAC-T112-AF28-W	UAC-T112-AF40-W
Sensor		
Pixel	2MP	
Size	1/3"	
Minimum illumination	0.01 lux (F1.6, AGC ON) 0 lux (white light on)	
Lens		
Lens	2.8mm	4.0mm
Lens mount	M12	
Angle of view	H: 100.9° V: 56.5° D: 121.8°	H: 82.5° V: 42.1° D: 98.6°
Illuminator		
Illuminator	One white-light illuminator	
Illumination distance	20m	
Lifetime	≥60,000 hours	
Video		
Resolution	1080P: 1920(H)×1080(V) 720P: 1280(H) ×720(V)	
Frame rate	TVI/AHD/CVI: 1080P@25fps (default), 1080P@30fps, 720P@25fps, 720P@30fps CVBS: PAL, NTSC	
Shutter time	PAL: 1/25s-1/50000s NTSC: 1/30s-1/50000s	
Image		
Exposure mode	Four modes: Global (default), BLC, HLC, DWDR	
Day/Night	24/7 color images	
Digital noise reduction	2D/3D	
White balance	Two modes: Auto (default), Manual	
WDR	DWDR	
Flip	Supports 180° horizontal flip, 180° vertical flip	
Defog	N/A	
Audio		
Microphone	Built-in Mic	
Camera audio	TVI: 1080P@25fps, 1080P@30fps CVI: 1080P@25fps, 1080P@30fps	
Interface		
Power	5.5mm power interface	
Video output	BNC, supports TVI/AHD/CVI/CVBS	
Operating environment		
Temperature	-30°C to 60°C (-22°F to 140°F)	
Humidity	≤95% (RH, non-condensing)	
Surge protection	4KV	
General		
Power	DC 12V(±25%), with reverse polarity protection, Max 2.3W	
Mount	Surface mount (default), optional backbox, wall mount bracket, pole mount bracket	

Dimensions	Φ118mm*96mm (diameter*height)
Material	Graphene+Plastic
Weight	209g(0.46lb)
OSD menu language	11 Languages English, German, Spanish(Latin America), French, Italian, Japanese, Korean, Polish, Portuguese(Brazil), Russian, Turkish
Certification	
EMC	CE-EMC (EN 55032,EN 61000-3-3,EN IEC 61000-3-2,EN 55035) FCC (FCC 47 CFR part15 B)
Safety	CE-LVD (EN 62368-1)
Environment	CE-RoHS (2011/65/EU;(EU)2015/863); WEEE (2012/19/EU)
Protection	IP67 (IEC 60529)

Dimensions

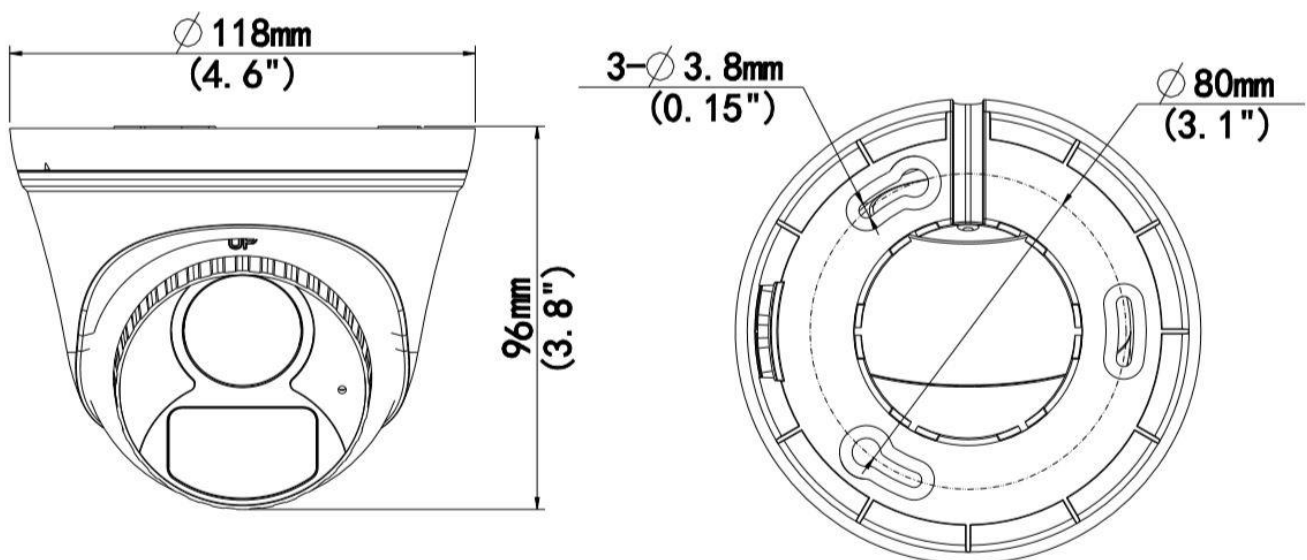

UAC-T112-AF28(40)-W

Accessories

TR-JB03-I-IN

Junction Box



TR-JB07/WM03-G-IN

Wall Mount



TR-WM03-D-IN

Wall Mount

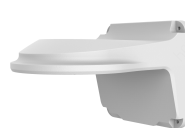

TR-WM07P-B

Wall Mount



TR-A01-IN

Waterproof Joint



TR-UP06-IN

Pole Mount



TR-UC08-C

Corner Mount

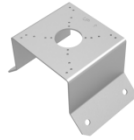

TR-SE24-A-IN

Pendant Mount



TR-CM24-IN

Pendant Mount



TR-SE24-IN

Pendant Mount



PWR-DC1201A-UK,
PWR-DC1201B-UK

Wall Plug-in UK
Power Adapter



PWR-DC1201A-US,
PWR-DC1201B-US

Wall Plug-in US Power
Adapter



PWR-DC1201A-EU,
PWR-DC1201B-EU

Wall Plug-in EU
Power Adapter



PWR-DC1201A-IND

Wall Plug-in IND Power
Adapter



Mount

TR-JB07/WM03-G-IN(TR-WM03-D-IN)+TR-UP06-IN

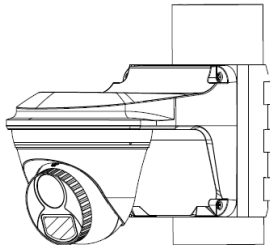

TR-JB03-I-IN

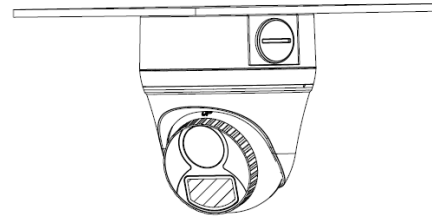

TR-JB07/WM03-G-IN(TR-WM03-D-IN)+TR-UC08-C

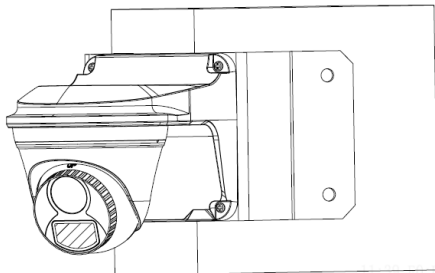

TR-CM24-IN+TR-JB03-I-IN

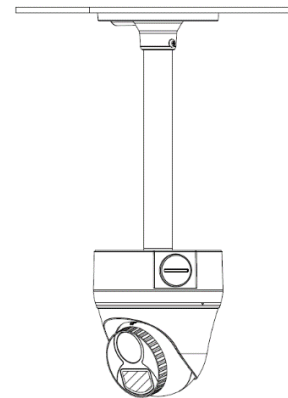

TR-WM07P-B

TR-JB07/WM03-G-IN(TR-WM03-D-IN)

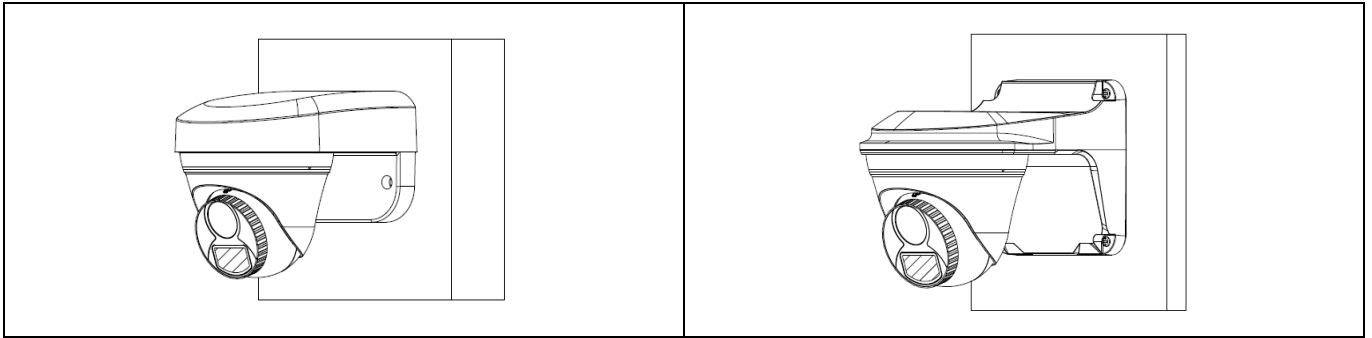

Zhejiang Uniview Technologies Co., Ltd.

Building No. 369, Xietong Road, Xixing Sub-district, Binjiang District, Hangzhou City, Zhejiang Province, China (310051)

Email: overseasbusiness@uniview.com; globalsupport@uniview.com

<https://www.uniview.com>

©2023 Zhejiang Uniview Technologies Co., Ltd. All rights reserved.

*Product specifications and availability are subject to change without notice.