

2MP Vandal-resistant Network IR Fixed Dome Camera

IPC322LB-TS-F



Key Features



- High quality image with 2MP, 1/2.8" CMOS sensor
- 2MP (1920*1080)@30/25fps; 720P (1280*720)@30/25fps
- Ultra 265, H.265, H.264
- Smart IR, up to 40m IR distance
- Day/night functionality
- 2D/3D DNR (Digital Noise Reduction)
- IP67 protection
- IK10 vandal resistant
- Support PoE power supply
- 2-Axis

Specifications

IPC322LB-TS-F		IPC322LB-TS-F			
Camera					
Sensor	1/2.8", progressive scan, 2.0 megapixel, CMOS				
Minimum Illumination	Colour: 0.01Lux (F2.0, AGC ON) 0Lux with IR				
Day/Night	IR-cut filter with auto switch (ICR)				
Shutter	Auto/Manual, 1 ~ 1/100000s				
Adjustment angle	Pan: 3° to 360°, Tilt: 0° to 75°				
S/N	>52dB				
WDR	DWDR				
Lens					
Lens Type	2.8mm and 4.0mm @1.6, Fixed-focal				
Lens Mount	M12				
Angle of View (H)	106.7°	87.5°			
Angle of View (V)	57.1°	46.3°			
Angle of View (O)	115.7°	92.4°			
DORI					
DORI Distance	Lens (mm)	Detect (m)	Observe (m)	Recognize (m)	Identify (m)
	2.8	43.4	17.4	8.7	4.3
	4.0	62.1	24.8	12.4	6.2
Illuminator					
IR Range	Up to 40m IR range				
Wavelength	850nm				
IR On/Off Control	Auto/Manual				
Video					
Video Compression	Ultra 265, H.265, H.264				
H.264 code profile	Baseline profile, Main profile, High profile				
Frame Rate	Main Stream: 1080P (1920*1080), Max 30fps; 720P (1280*720), Max 30fps Sub Stream: D1 (720*576), Max 30fps; 640*360,Max 30fps; 2CIF(704*288), Max 30fps; CIF(352*288), Max 30fps;				
Video Bit Rate	128 Kbps~6 Mbps				
OSD	Up to 4 OSDs				
Privacy Mask	Up to 4 areas				
ROI	Up to 8 areas				
Motion Detection	Up to 4 areas				
Image					
White Balance	Auto/Outdoor/Fine Tune/Sodium Lamp/Locked/Auto2				
Image Setting	Image rotation, brightness, saturation, contrast, sharpness, gain adjustable by web browser				
Digital noise reduction	2D/3D DNR				
Smart IR	Supported				
Flip	Normal/Vertical/Horizontal/180°				
Dewarping	N/A				

HLC	Supported
BLC	Supported
Defog	Digital Defog
Network	
Protocols	IPv4, IGMP, ICMP, ARP, TCP, UDP, DHCP, RTP, RTSP, RTCP, RTMP, DNS, DDNS, NTP, UPnP, HTTP
Compatible Integration	API, SDK
User/Host	Up to 32 users. 2 user levels: administrator and common user
Security	Password protection, Strong password, HTTPS encryption, Export operation logs, Basic and digest authentication for RTSP, Digest authentication for HTTP, TLS 1.2, WSSE and digest authentication for ONVIF
Client	EZStation EZView EZLive
Web Browser	Plug-in free live view: Chrome 57.0+, Firefox 58.0+, Edge 16+
Interface	
Network	1 * RJ45 10M/100M Base-TX Ethernet
Certifications	
EMC	FCC: FCC Part 15
Safety	CE: EN 60950-1 UL: UL60950-1 IEC 60950-1
General	
Power	DC 12V±25%, PoE (IEEE 802.3af)
	Power consumption: Max 5.0W
Power Interface	Ø 5.5mm coaxial power plug
Dimensions (Ø x H)	Φ109 x 81mm (Ø4.3" x 3.2")
Weight	0.35kg (0.77lb)
Material	Metal + Plastic
Working Environment	-30°C ~ 60°C (-22°F ~ 140°F), Humidity: ≤95% RH (non-condensing)
Storage Environment	-30°C ~ 60°C (-22°F ~ 140°F), Humidity: ≤95% RH (non-condensing)
Surge Protection	4KV
Reset Button	N/A
Ingress Protection	Ingression protection: IP67 Vandal resistant: IK10

Dimensions

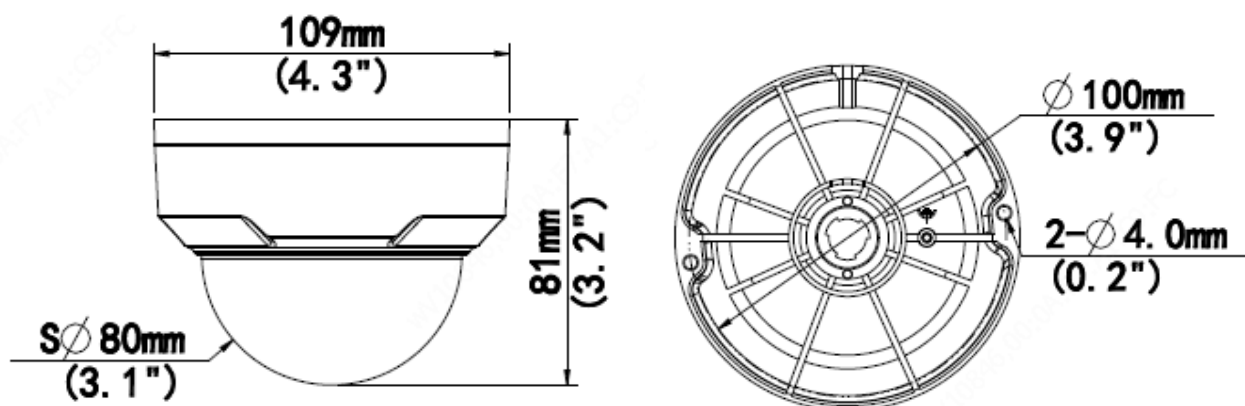

Accessories

TR-JB03-G-IN



TR-JB07/WM03-G-IN



TR-WM03-D-IN

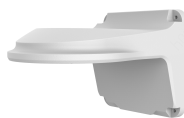

TR-UM06-E-IN



TR-UP06-IN



TR-A01-IN



TR-SE24-IN



TR-SE24-A-IN



TR-CM24-IN

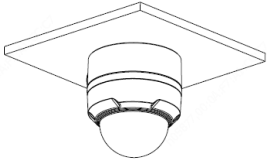
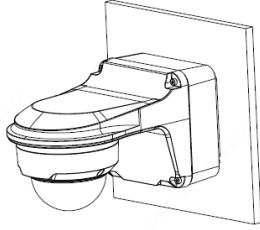
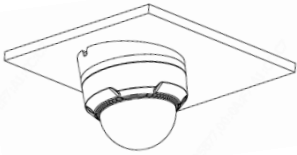
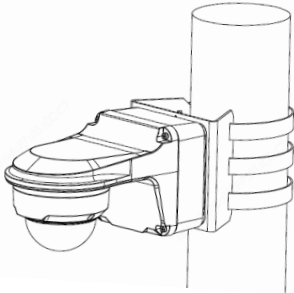
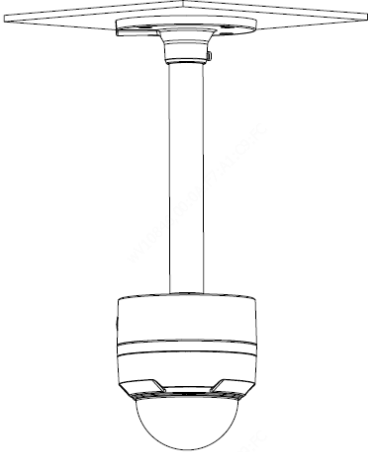

Junction Mount	Pole Mount
TR-JB03-G-IN	TR-JB07/WM03-G-IN
	
TR-UM06-E-IN	TR-JB07/WM03-G-IN+TR-UP06-IN
	
TR-CM24-IN+TR-JB03-G-IN	
	

Zhejiang Uniview Technologies Co., Ltd.

Building No.10, Wanlun Science Park, Jiangling Road 88, Binjiang District, Hangzhou, Zhejiang, China (310051)

 Email: overseasbusiness@uniview.com; globalsupport@uniview.com
<http://www.uniview.com>

©2020 Zhejiang Uniview Technologies Co., Ltd. All rights reserved.

*Product specifications and availability are subject to change without notice.