

2MP 25X LightHunter Network PTZ Dome Camera

IPC6422SR-X25-VF-B



Features

- High quality image with 2MP, 1/2.8" CMOS sensor
- 1920*1080@60fps in the main stream
- Ultra 265, H.265, H.264, MJPEG
- 25X Optical Zoom
- Smart intrusion prevention, support false alarm filtering, include Cross Line, Intrusion, Enter Area, Leave Area detection
- Face capture, automatic selection of best snapshots, support face detection masked area
- People Counting, support people flow counting and crowd density monitoring, suitable for different statistical scenarios
- LightHunter technology ensures ultra-high image quality in low illumination environment
- Smart IR, up to 100m (328ft) IR distance
- DC 12V±25% or PoE+ (IEEE 802.3at)
- Alarm 2 in and 1 out, Audio 1 in and 1 out
- IP67 ingress protection
- IK10 vandal resistant

Specifications

Camera	Description
Sensor	1/2.8" CMOS
Min. Illumination	Colour: 0.001 Lux (F1.5, AGC ON) 0 Lux with IR
Day/Night	IR-cut filter with auto switch (ICR)
Shutter	Auto/Manual, 1 ~ 1/100000s
WDR	120dB
S/N	>52dB
Lens	Description
Focal Length	5 ~ 125 mm
Digital Zoom	16X
Optical Zoom	25X
Iris	F1.5 ~ F4.0
Field of View (H)	54.37° ~ 2.68°
Field of View (V)	32.23° ~ 1.51°
Field of View (D)	66.88° ~ 3.16°
DORI	Description
DORI Distance(Lens)	5~125(mm)
DORI Distance(Detect)	77.6m~1939.7m(254.5ft~6363.7ft)
DORI Distance(Observe)	31.0m~775.9m(101.8ft~2545.5ft)
DORI Distance(Recognize)	15.5m~387.9m(50.9ft~1272.7ft)
DORI Distance(Identify)	7.8m~194.0m(25.5ft~636.4ft)
Illuminator	Description
Illumination Distance(IR)	100 m (328.1 ft)
IR On/Off Control	Auto/Manual
Wavelength	850 nm
Video	Description
Privacy Mask	24 areas, up to 4 areas per scene
Video Compression	Ultra 265; H.265; H.264; MJPEG
Frame Rate	Main Stream: 2MP(1920*1080),Max 60fps

	Sub Stream: 2MP (1920*1080), Max 60fps Third Stream: D1 (720*576), Max 60fps
Video Bit Rate	128 Kbps ~ 16 Mbps
U-code	Support
ROI	Support
Video Stream	Triple Streams
OSD	Up to 10 OSDs
Intelligent	Description
Face Capture	Support; Face attributes: Gender, Age range, Glasses, Mask
Exception Detection	Object Removed; Object Left Behind
People Counting	Support People Flow Counting and Crowd Density Monitoring
Smart Intrusion Prevention	Support False Alarm Filtering: Cross Line Detection, Intrusion Detection, Enter Area Detection, Leave Area Detection
Image	Description
Defog	Digital Defog
White Balance	Auto; Outdoor; Fine Tune; Sodium Lamp; Locked; Auto2
Digital Noise Reduction	2D/3D DNR
Smart IR	Support
Flip	Normal; Flip Vertical; Flip Horizontal; 180°
HLC	Support
BLC	Support
Heatwave Reduction	Support
Events	Description
Basic Detection	Motion Detection; Audio Detection; Tampering Alarm
General Function	Watermark; IP Address Filtering; Access Policy; ARP Protection; RTSP Authentication; User Authentication; Alarm Input; Alarm Output
Audio	Description
Audio Compression	G.711U; G.711A
Audio Bitrate	128 Kbps
Two-way Audio	Support
Suppression	Support
Sampling Rate	16KHZ

Storage	Description
Edge Storage	Micro SD, up to 512 GB
Network Storage	ANR; NAS (NFS)
Network	Description
Protocols	SSH; IGMP; RTP; RTCP; SMTP; IPv4; IPv6; ICMP; ARP; TCP; UDP; DHCP; PPPoE; RTSP; RTMP; DNS; DDNS; NTP; FTP; UPnP; HTTP; HTTPS; 802.1x; SNMP; QoS; SSL/TLS
Compatible Integration	ONVIF (Profile S, Profile G, Profile T, Profile M); API; SDK
User/Host	Up to 32 users. 3 user levels: administrator, common user and operator
Security	TLS1.3; Password Protection; Strong Password; HTTPS Encryption; Export Operation Logs; Basic and Digest Authentication for RTSP; Digest Authentication for HTTP; TLS 1.2; WSSE and Digest Authentication for ONVIF
Client	EZStation; EZLive; EZView
Web Browser	Plug-in required live view: IE 10 and above, Chrome 45 and above, Firefox 52 and above, Edge 79 and above
PTZ	Description
Number of Presets	1024
Preset Patrol	16 patrols, up to 64 presets for each patrol
Route Patrol	16 patrols, up to 32 actions for each patrol
Recorded Patrol	16 patrols, up to 128 actions for each patrol
Patrol Stay Time	15s ~ 1800s
Preset Image Freeze	Support
Home Position	Support
Interface	Description
Audio I/O	1/1
Alarm I/O	2/1
Serial Port	1 * RS485
Built-in Mic	N/A
Built-in Speaker	N/A
WIFI	N/A
Network	1 x RJ45 10M/100M Base-TX Ethernet
Video Output	1 BNC
Certification	Description

EMC	CE-EMC (EN 55032: 2015+A1:2020,EN 61000-3-3: 2013+A1: 2019,EN IEC 61000-3-2: 2019+A1: 2021,EN 55035: 2017+A11:2020) FCC (FCC CFR 47 part15 B, ANSI C63.4-2014)
Safety	CE LVD (EN 62368-1:2014+A11:2017) UL (UL 62368-1, 2nd Ed., Issue Date: 2014-12-01)
Environment	CE-RoHS (2011/65/EU;(EU)2015/863)
Protection	IP67 (IEC 60529:1989+AMD1:1999+AMD2:2013) IK10 (IEC 62262:2002)
General	Description
Power	DC12V(±25%,3A), PoE+(IEEE 802.3at)
Power Consumption	MAX 21W
Power Interface	Ø 5.5mm coaxial power plug
Dimensions	Ø 162 x 295mm(Ø 6.4" x 11.6")
Weight	3.05kg(6.72lb)
Working Environment	-40 °C ~ 70 °C (-40 °F ~ 158 °F), Humidity: ≤95% RH (non-condensing)
Storage Environment	-40 °C ~ 70 °C (-40 °F ~ 158 °F), Humidity: ≤95% RH (non-condensing)
Surge Protection	6KV
Reset Button	Support
Web Client Language	22 Languages Traditional Chinese, English, Simplified Chinese, Polish, German, Russian, French, Korean, Dutch, Czech, Portuguese (Europe), Portuguese (Brazil), Japanese, Thai, Turkish, Spanish (Latin America), Spanish (Europe), Hungarian, Italian, Vietnamese, Arabic, Slovak

Dimensions

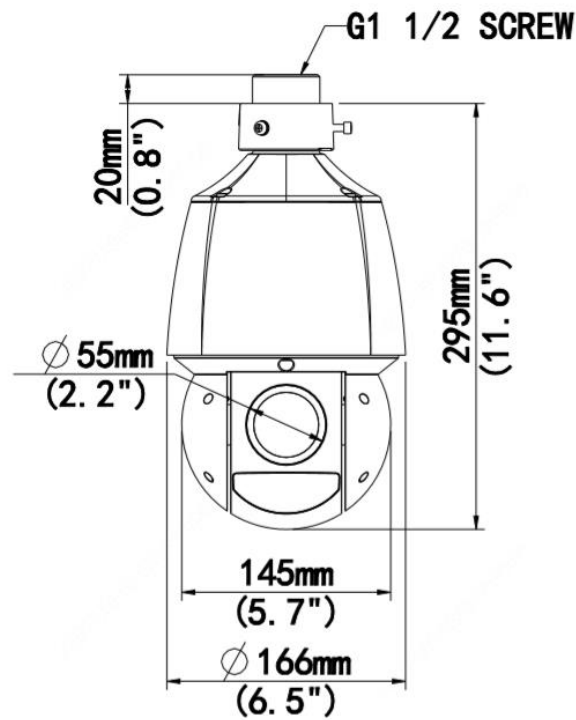
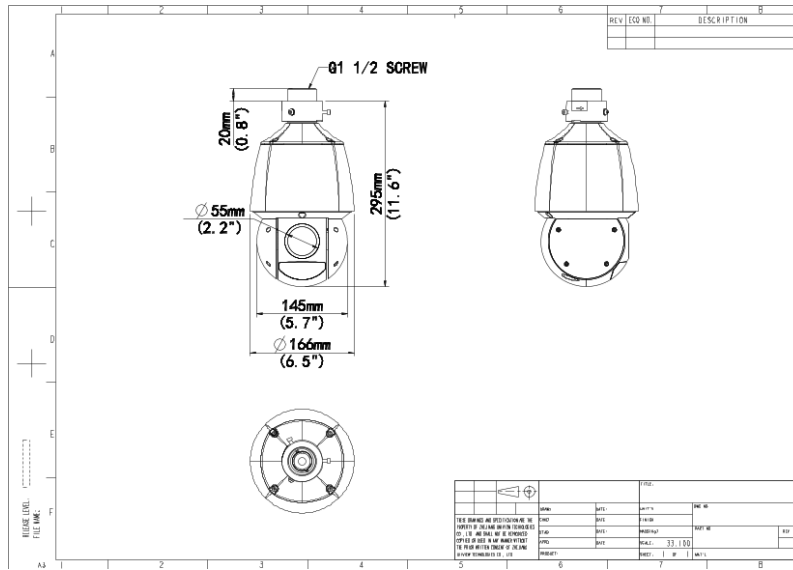

Zhejiang Uniview Technologies Co., Ltd.

No. 369, Xietong Road, Xixing Sub-district, Binjiang District, Hangzhou City, 310051, Zhejiang Province, China

Email: overseasbusiness@uniview.com; globalsupport@uniview.com

<http://www.uniview.com>

©2023-2024 Zhejiang Uniview Technologies Co., Ltd. All rights reserved.

*Product specifications and availability are subject to change without notice.

*Despite our best efforts, technical or typographical errors may exist in this document. Uniview cannot be held responsible for any such errors and reserves the right to change the contents of this document without prior notice.